

**Applicable Model**

R23P  
(Wall Mounting)

**Drawing Title**

Intercom Panel

**Drawing Unit**

mm

**Drawing Scale**

Not to scale

**DRAFT  
SUBJECT TO  
CHANGE**

**Last Revised**

December 31,2019

**Drawing Version**

V1.0

**Page**

1 of 3

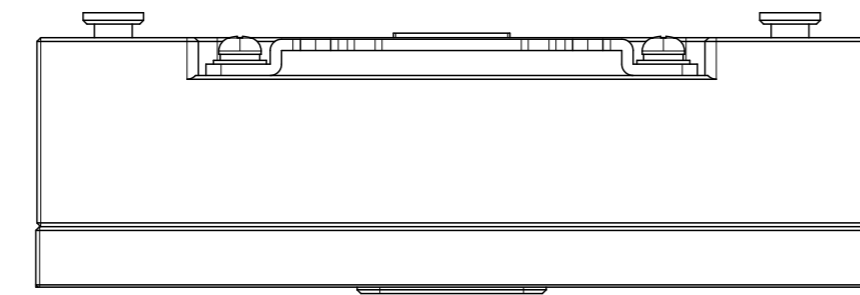

5 TOP VIEW

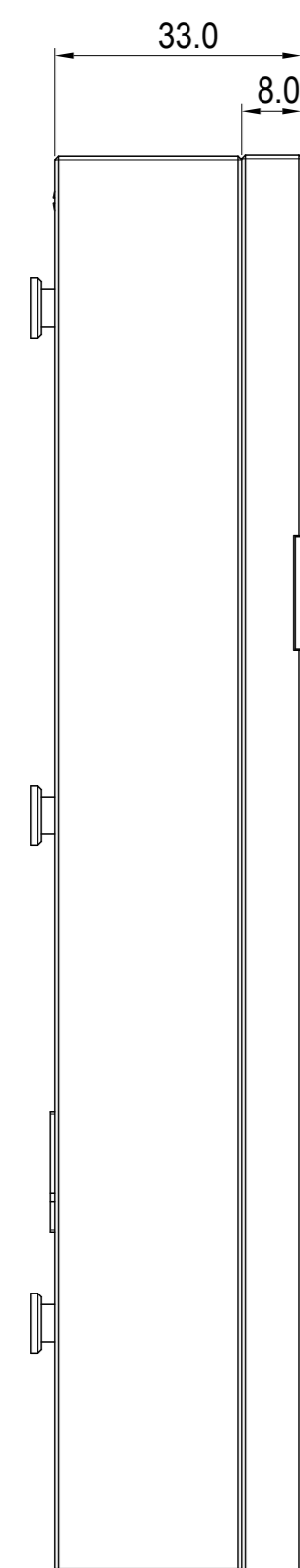

2 RIGHT VIEW

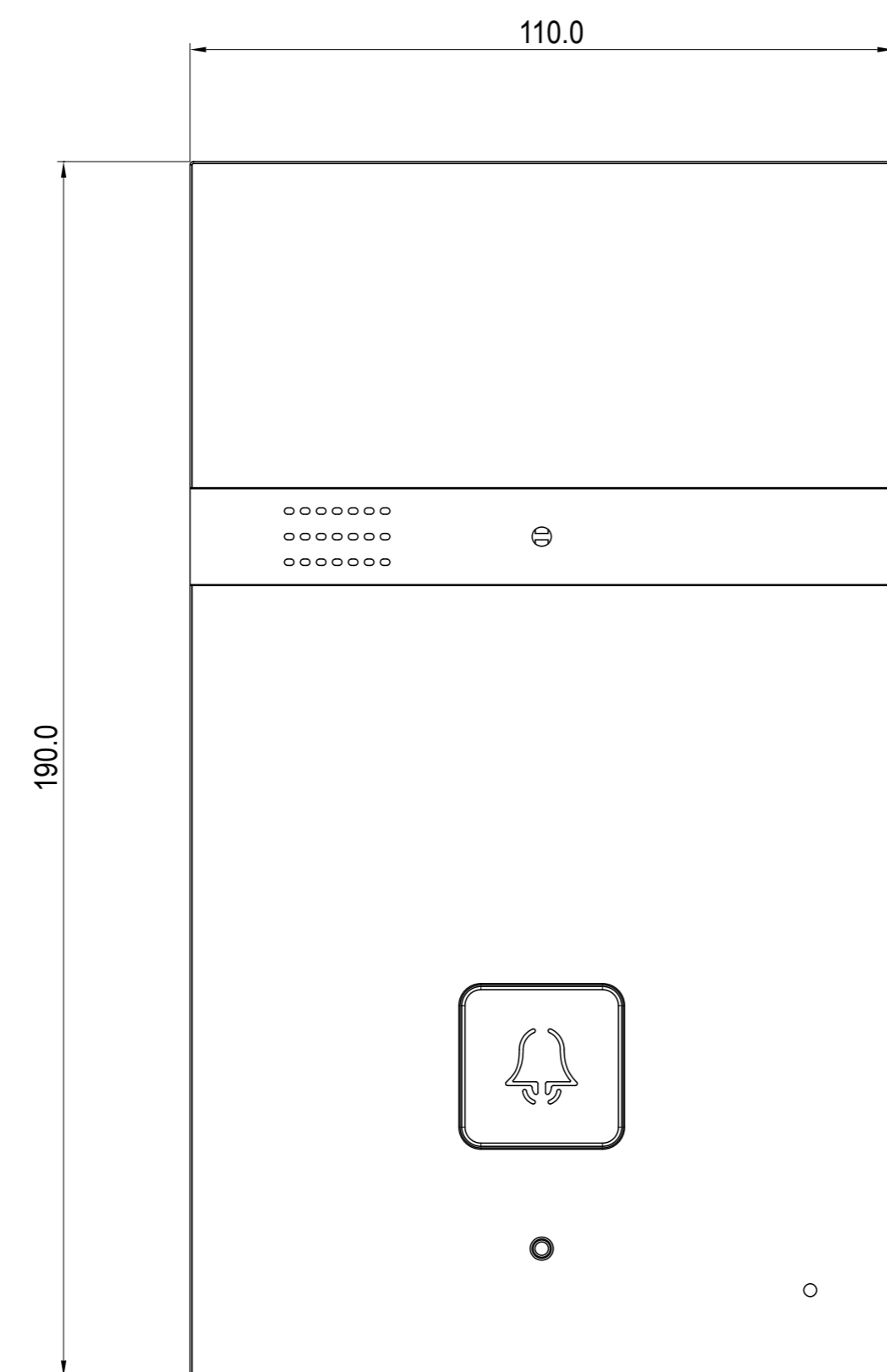

1 FRONT VIEW

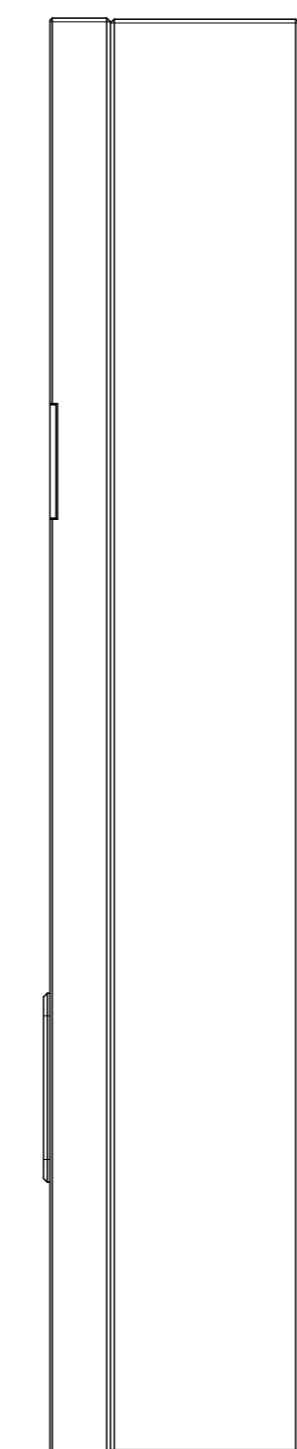

3 LEFT VIEW

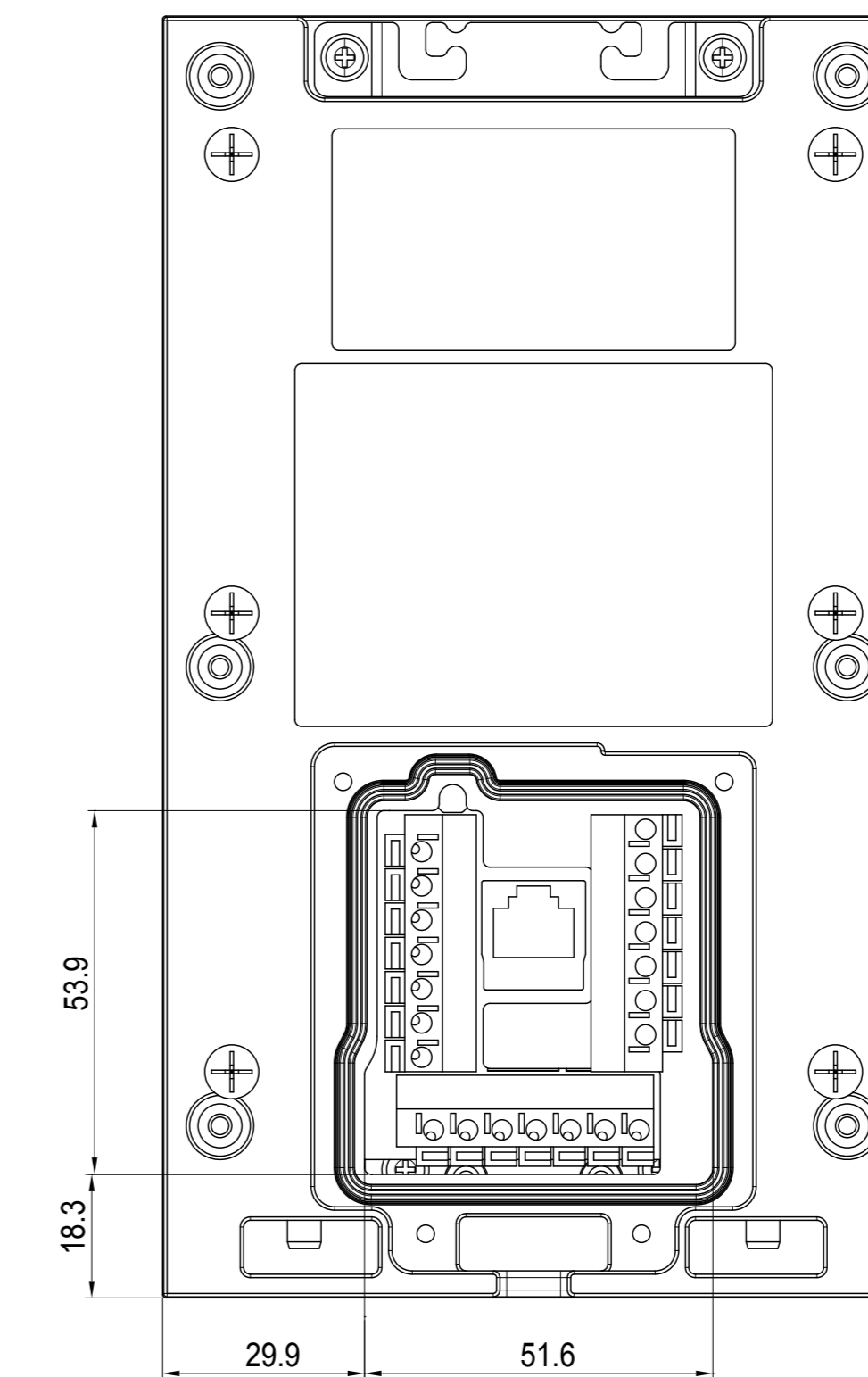

4 BACK VIEW

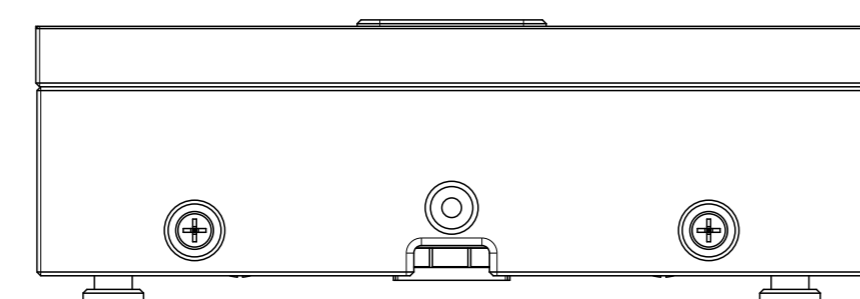

6 BOTTOM VIEW

**Applicable Model**

R23P  
(Wall Mounting)

**Drawing Title**

Wall Mounting Bracket

**Drawing Unit**

mm

**Drawing Scale**

Not to scale

**DRAFT  
SUBJECT TO  
CHANGE**

**Last Revised**

December 31,2019

**Drawing Version**

V1.0

**Page**

2 of 3

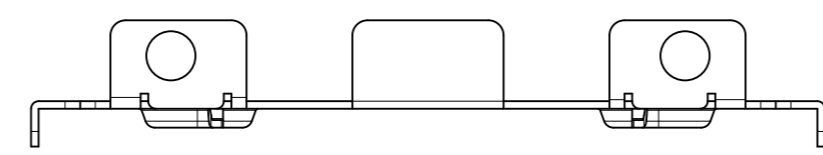

5 TOP VIEW

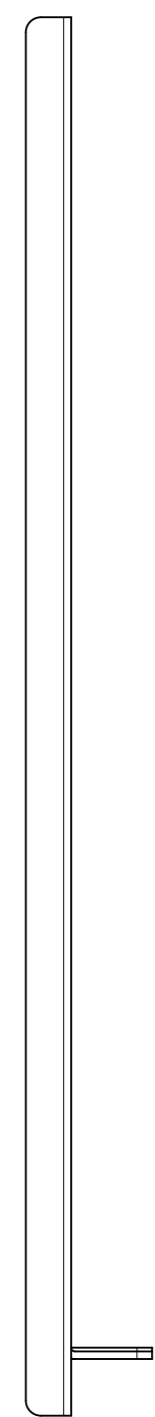

2 RIGHT VIEW

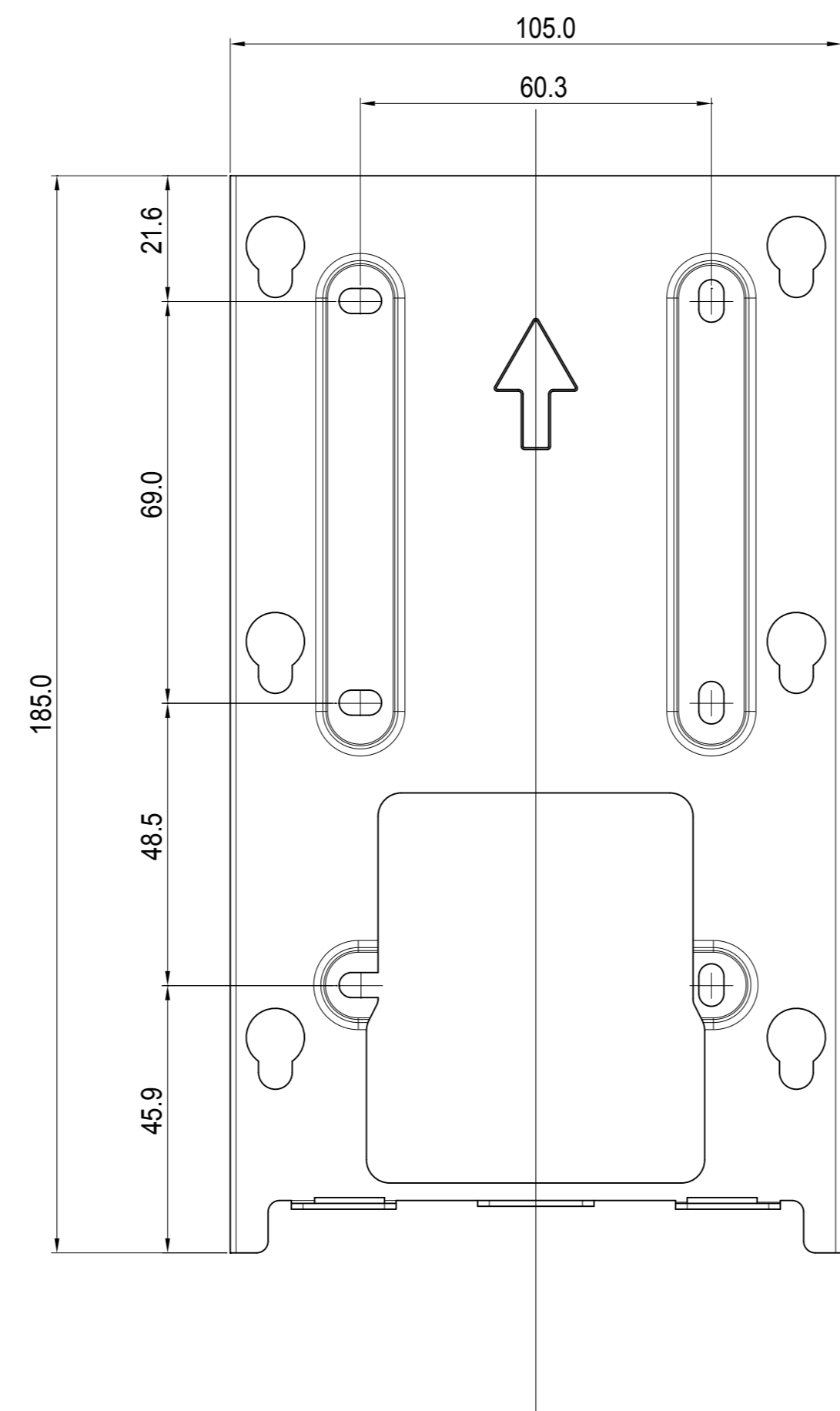

1 FRONT VIEW

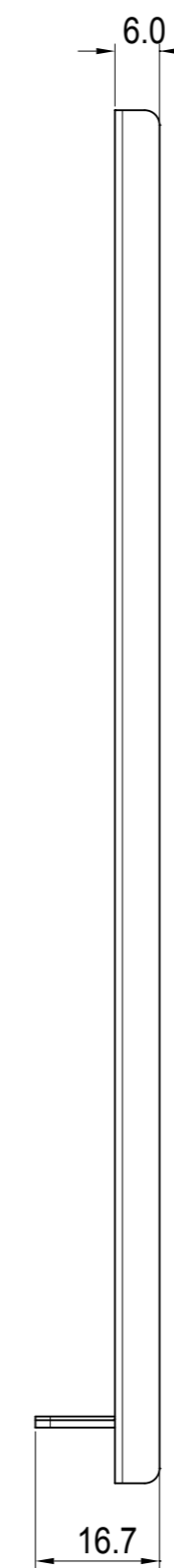

3 LEFT VIEW

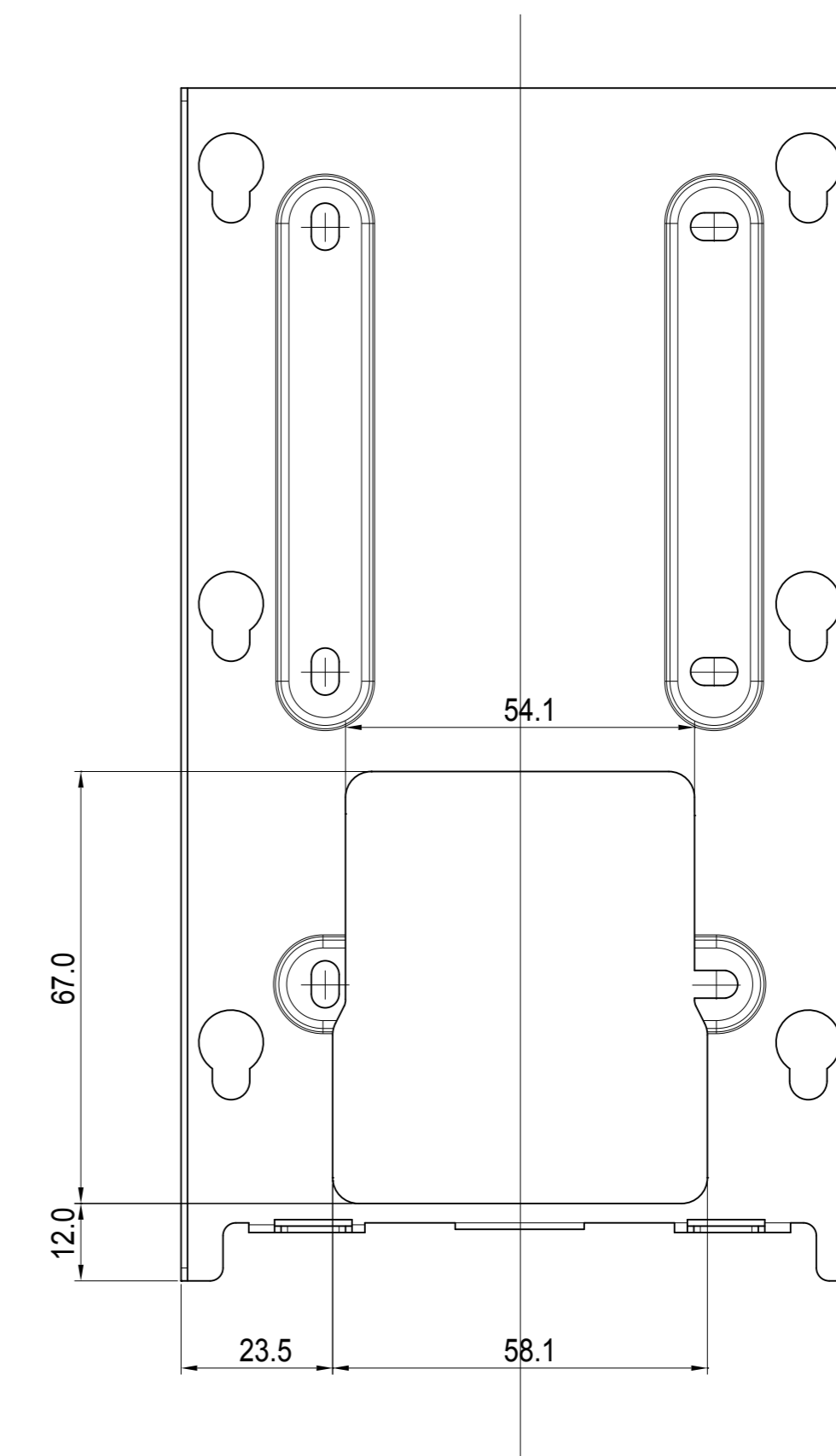

4 BACK VIEW

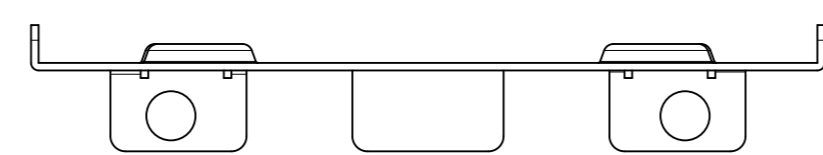

6 BOTTOM VIEW

**Applicable Model**

R23P  
(Wall Mounting)

**Drawing Title**

Placement

**Drawing Unit**

mm

**Drawing Scale**

Not to scale

**DRAFT  
SUBJECT TO  
CHANGE**

**Last Revised**

December 31,2019

**Drawing Version**

V1.0

**Page**

3 of 3

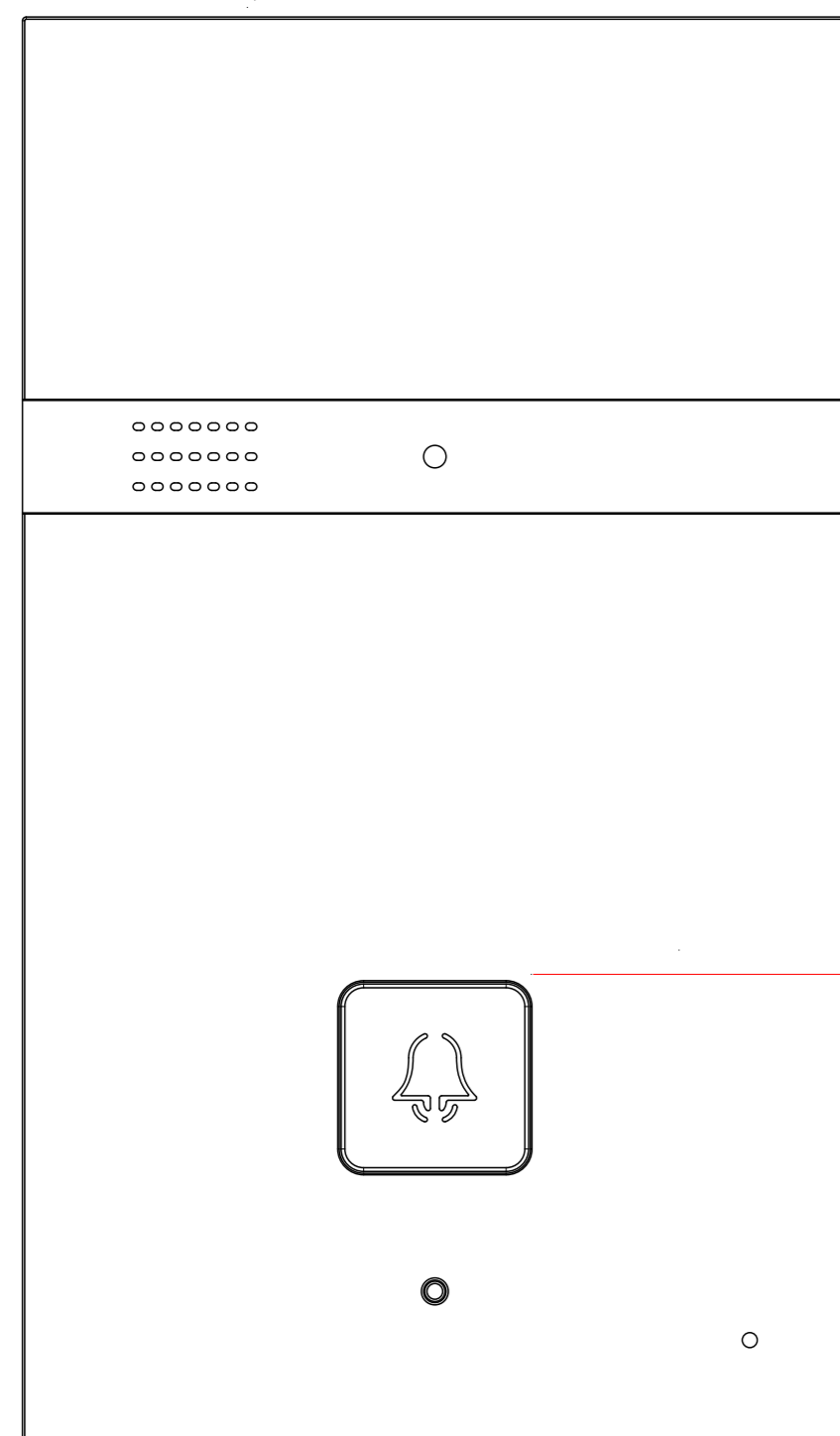

1 INTERCOM PANEL FRONT VIEW

1121mm TO BOTTOM OF PANEL

1182mm MAX TO TOP OF USABLE BUTTON

ADA Compliance Requirement

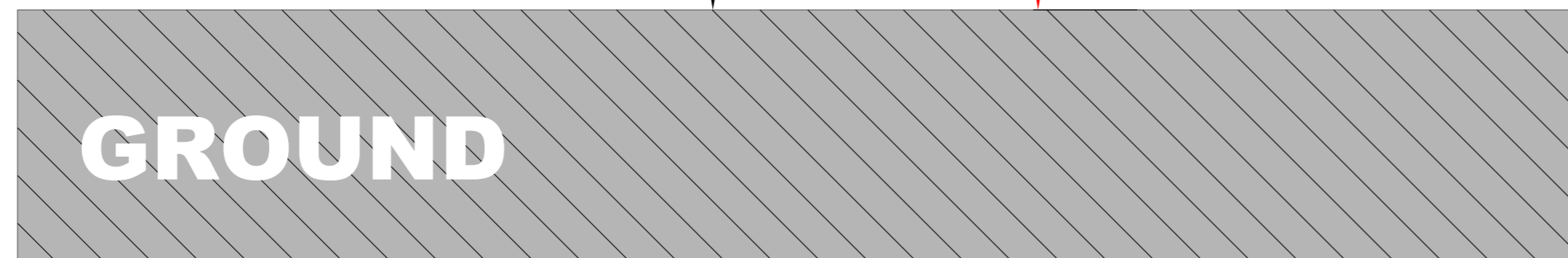

**GROUND**

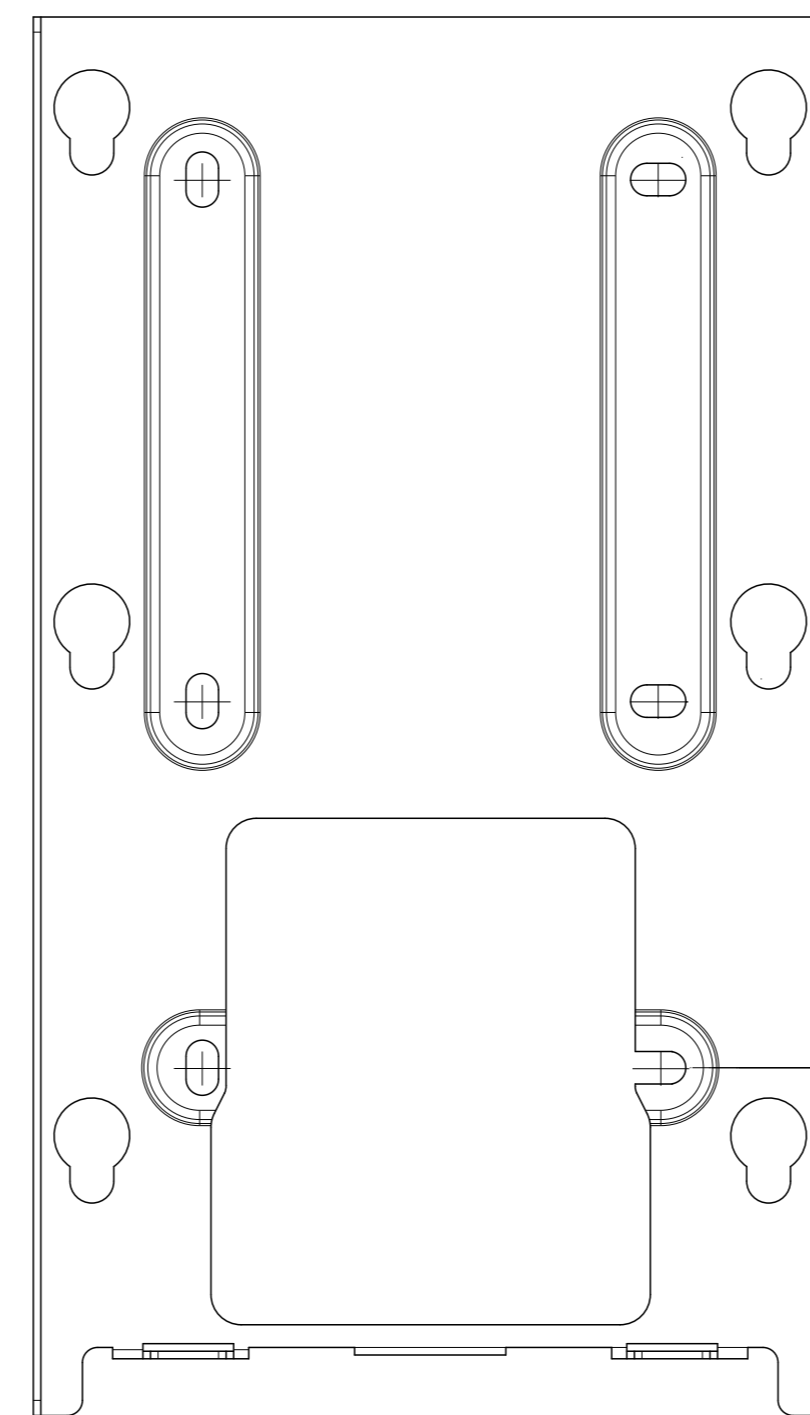

2 FRONT VIEW: WALL MOUNTING BRACKET PLACEMENT

1124mm TO BOTTOM OF BRACKET

1218mm TO SCREW HOLE CENTER OF BRACKET

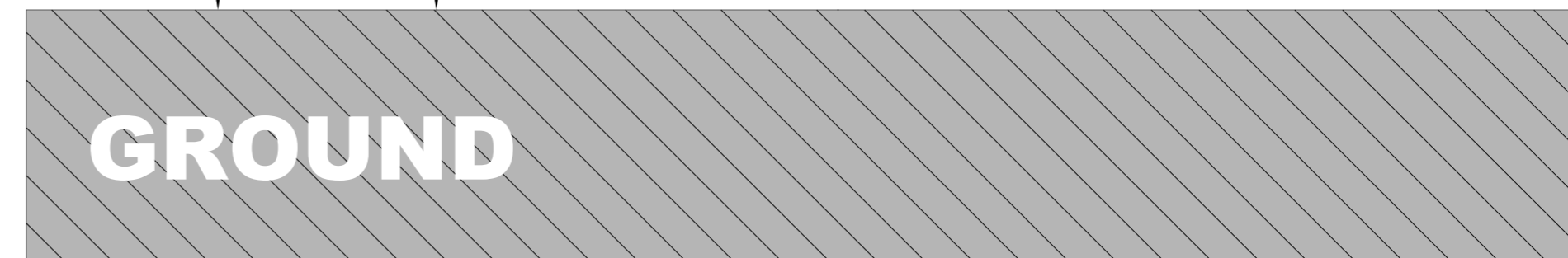

**GROUND**

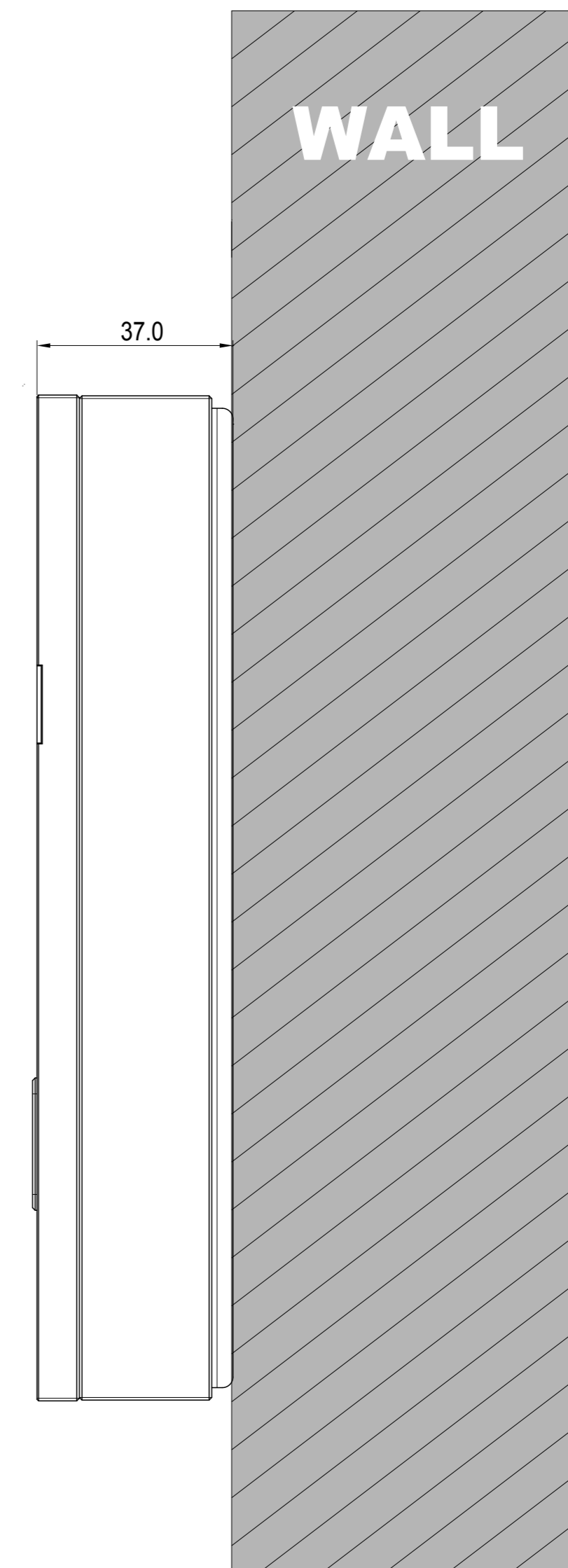

3 SIDE VIEW:INTERCOM ON WALL